

## Trolley Duct Lifter - MHSMER5001

- Heavy-duty design
- Rolls easily through a single door in the upright position
- Quick setup requires no tools
- Compact design, legs fold up for easy storage

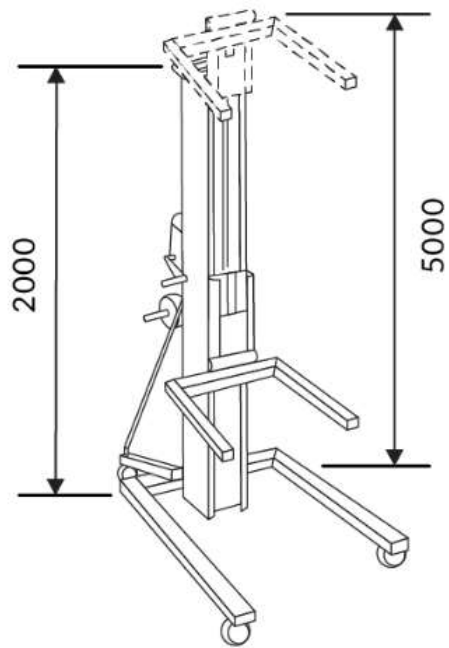

<b>Model</b>	MHSMER5001
<b>Capacity</b>	300kg
<b>Width-straddle Min</b>	750mm
<b>Unit Height</b>	2000mm
<b>Max Working Height</b>	5000mm
<b>Warranty</b>	1 year